

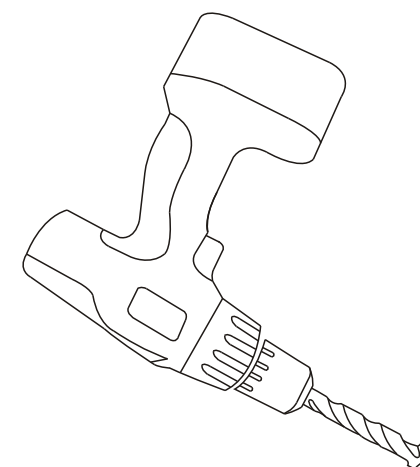

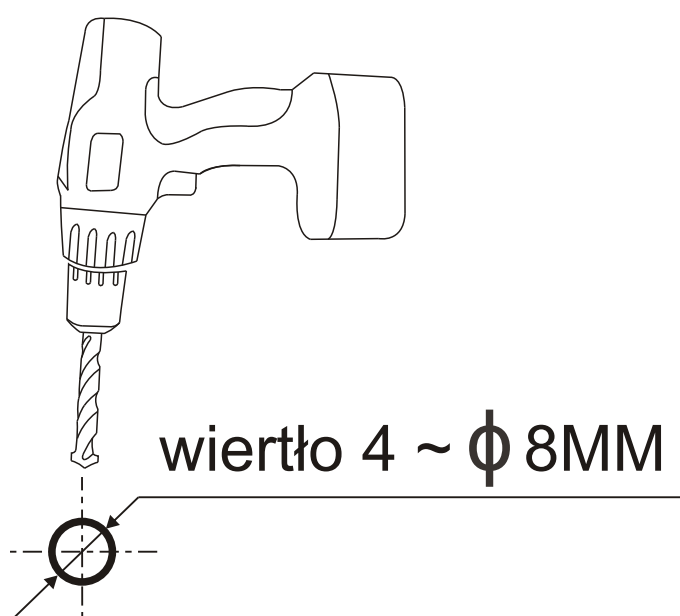





SZABLON MONTAŻOWY

260MM



Rekomendowana wysokość montażu

	(mężczyźni)	1200MM (47")
	(kobiety)	1150MM (45")
	(dzieci 4-7 lat)	812MM (32")
	(dzieci 8-10 lat)	860MM (34")
	(dzieci 11-13 lat)	950MM (37")
	(dzieci 14-16 lat)	1150MM (45")
	(niepełnosprawni)	1000MM (39")

wysokość od podłogi